

Manual: No. 7387 **INSTALLATION**

CLOSURES

*On existing or aluminium posts
to be affixed with screws or sealed*



(Document reserved for installers)

Contents

Required equipment p.2
Installation instructions p.3
Installing the closures on existing post p.4
Installing the closures on aluminum posts to be affixed with screws p.6
Installing the closures on aluminum posts to be sealed..... p.10

Required equipment

- Hammer drill
- Set of steel/concrete drill bits
- Electric screwdriver with end-pieces
- Allen keys + Flat wrenches
- Screwdriver
- Hammer/chisel
- Spirit level
- Plumb bob
- Hacksaw
- Angle grinder
- Tape measure
- Appropriate screws and pins for the supports
- 66 mm shims

Installation instructions

CAUTION!



To ensure that this product is assembled, used and maintained in complete safety, it is important to follow the instructions provided in this document. For everyone's safety, please observe the precautionary measures below.



- * Before beginning the assembly, read this manual carefully.
- * This closure must be installed by a professional technician.
- * All the parts delivered are specifically sized for this product. Adding and/or using other parts may be detrimental to safety and may affect the product's warranty.
- * Any modification or improvement of this closure must be compliant with the standard EN 13241 + A2.
In this case, a "modification/transformation" file must be created by the installer as per the standard EN 12635 annex C.
- * Use the appropriate tools to install these products.
- * Ensure that the assembly area is clear, clean and clearly marked out.
- * Ensure that no other people are present at the assembly site apart from the installers. Non-authorized persons (children for example!) who are present at the site risk injury during assembly.
- * All the components of this closure must be installed in compliance with the installation instructions provided in this manual.
- * All the requirements of the standards EN 13241 + A2 must be met and verified if necessary.

Installing the closures on existing posts

Before installing the closure, **check:**

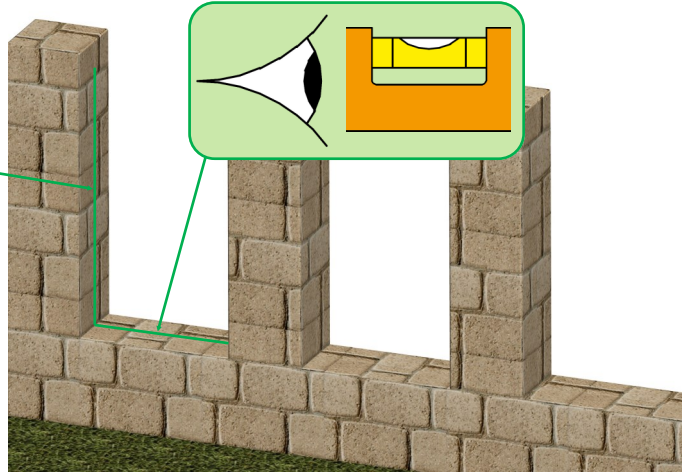
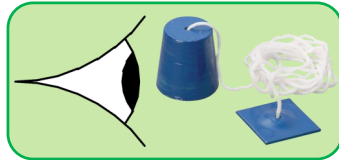

Position the closure and mark the attachment points:

Normal clearance

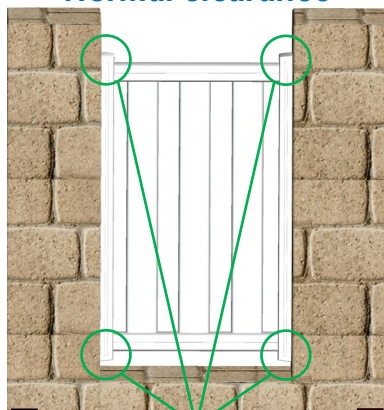

OPTION: Reduced clearance

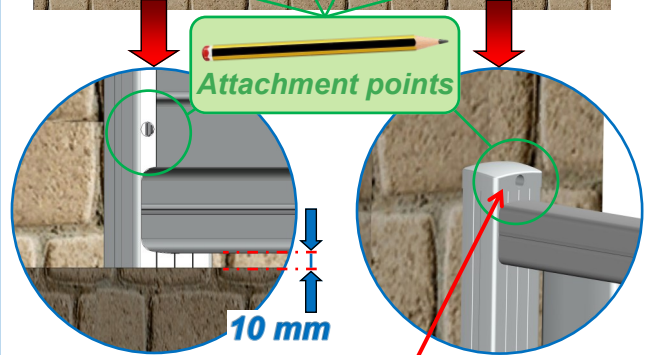
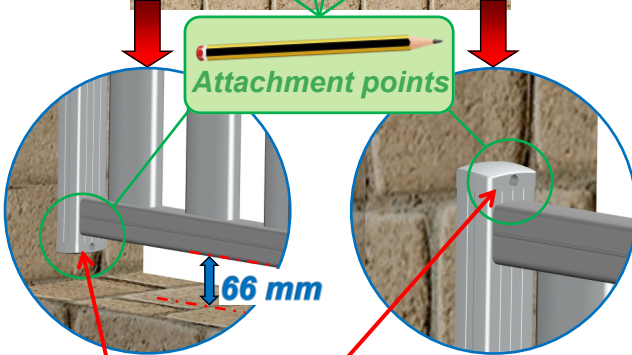
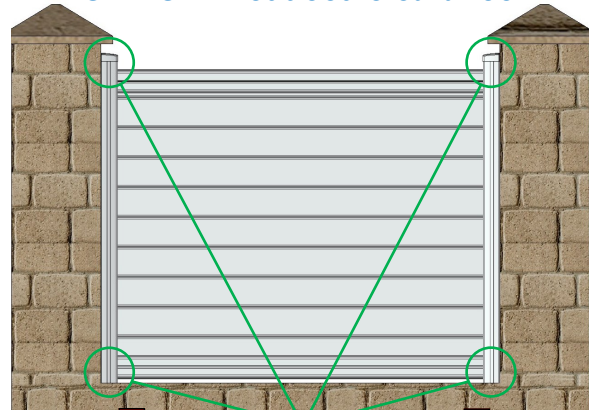

Then remove the closure

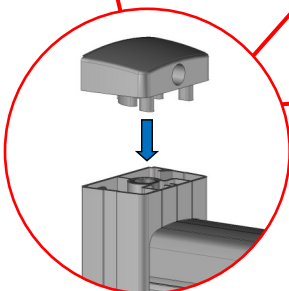

Please note: If the attachment caps have not been fitted:

- They are in the accessory pack.
- Forcibly insert them using a mallet while protecting the floor so that the caps don't get scratched.



Preparing the fittings:

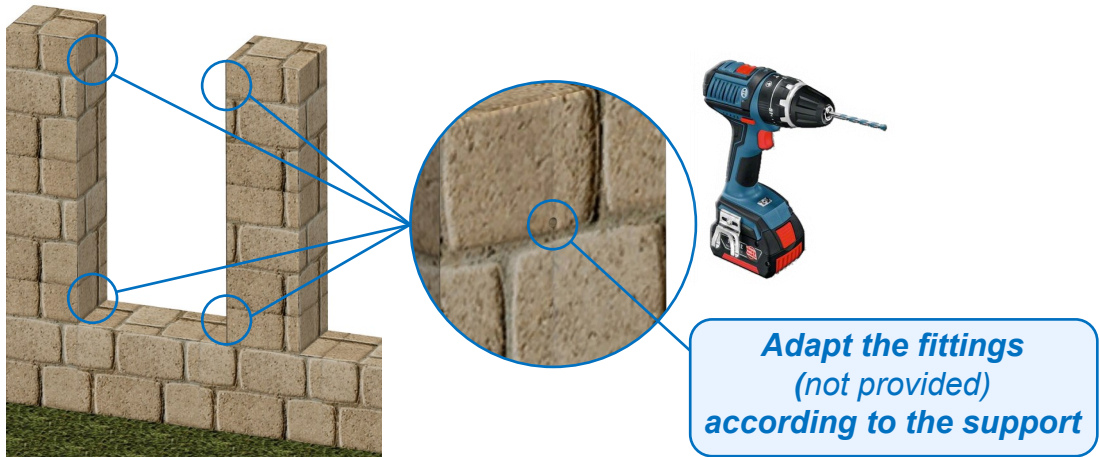

Reposition the closure, according to the dimensions and attach it:

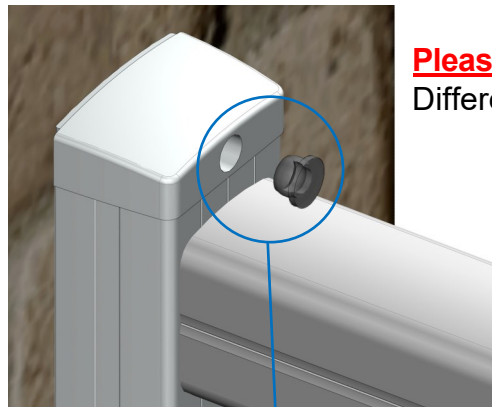
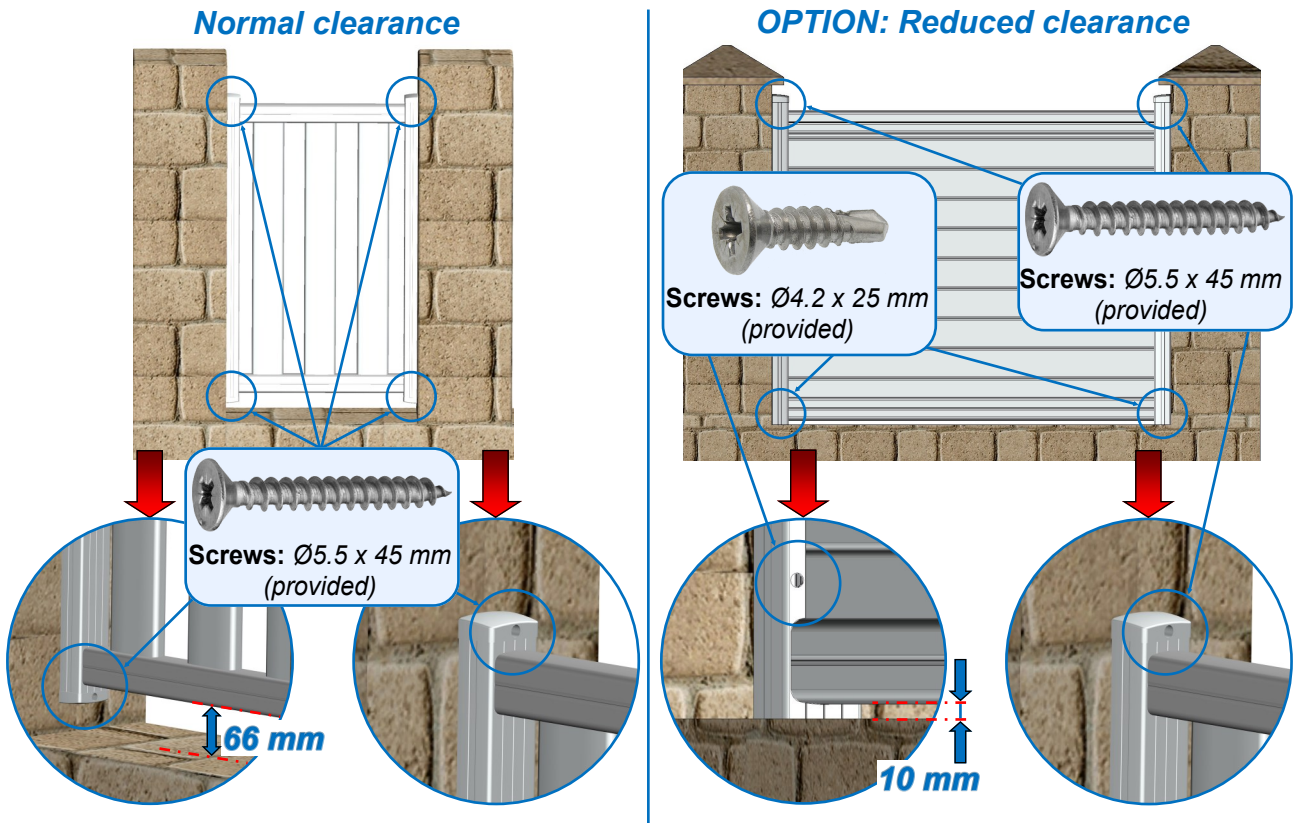

Then insert the stopping plugs

Please note: **OPTION reduced clearance**
Different bottom plugs = Ø10 mm.

Repeat this process to install the rest of the closures.

Installing the closures on aluminum posts to be affixed with screws

Before installing the closure, **check:**

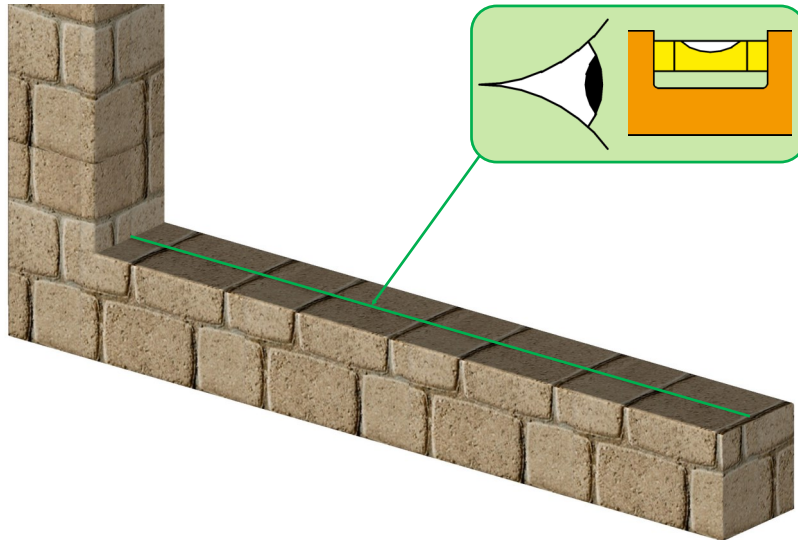

Install the 1st post:

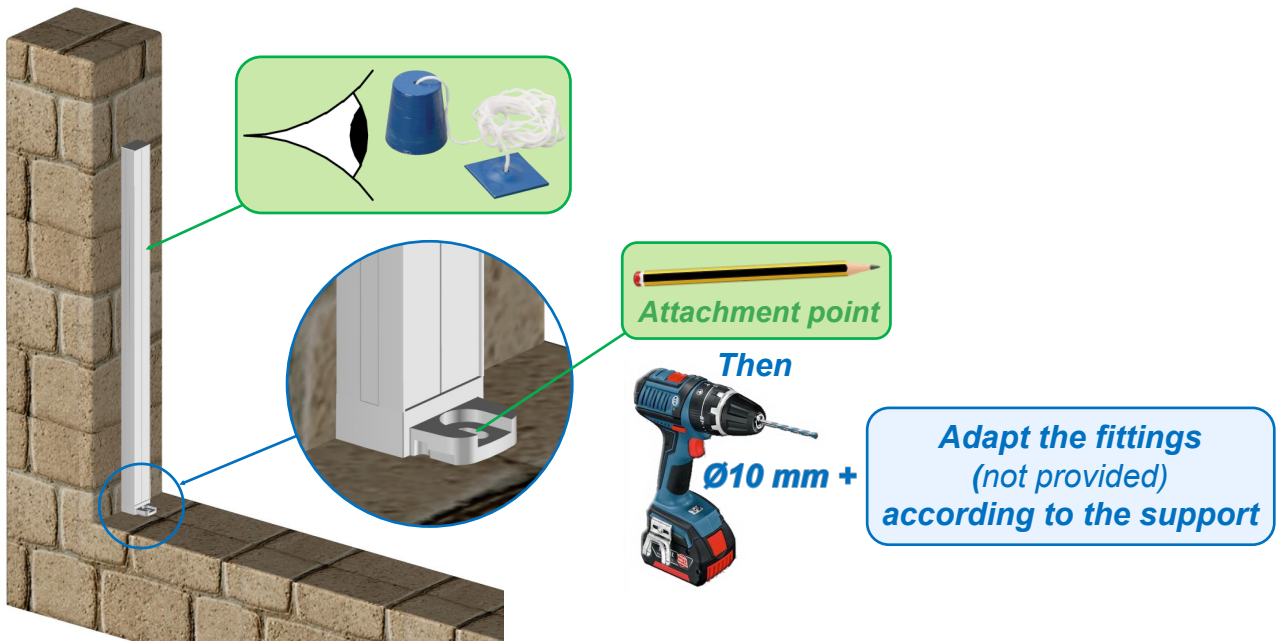

Mark the attachment points on the 1st post:

Attachment points

Please note: If the attachment caps have not been fitted:
 - They are in the accessory pack.
 - Forcibly insert them using a mallet while protecting the floor so that the caps don't get scratched.

66 mm

Drill the holes in the 1st post and secure the closure with screws at the top:

Ø4 mm

Screws: Ø5.5 x 45 mm (provided)

66 mm

Install the 2nd post:

Attachment points

Unscrew and remove the closure, in order to drill the holes:

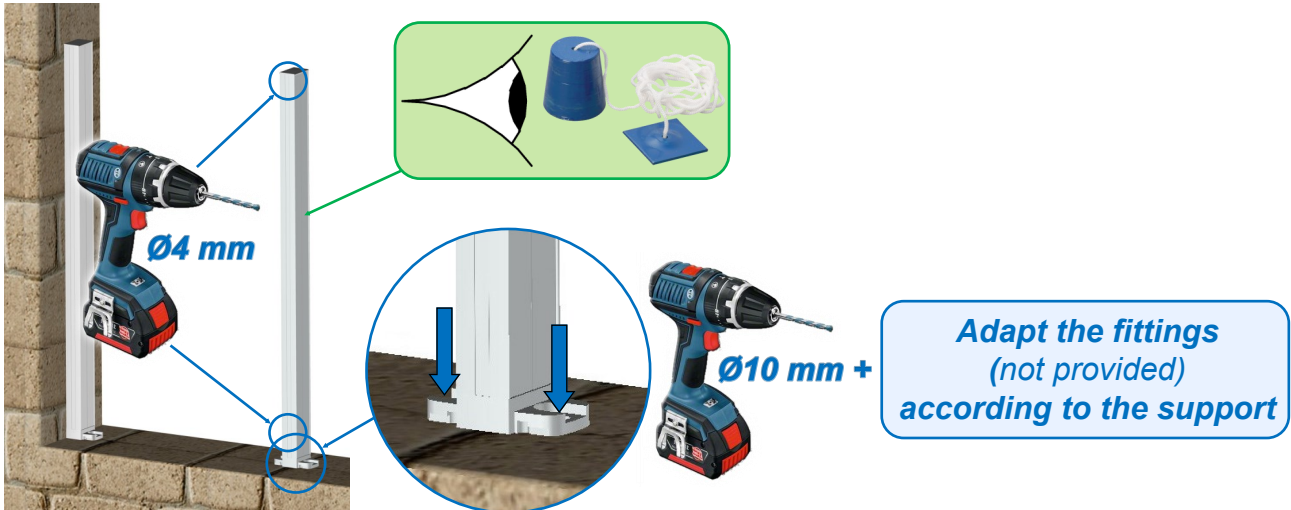

Check the clamp screws on the 2 posts, (they must not exceed the bearing plates), then attach the screw covers:

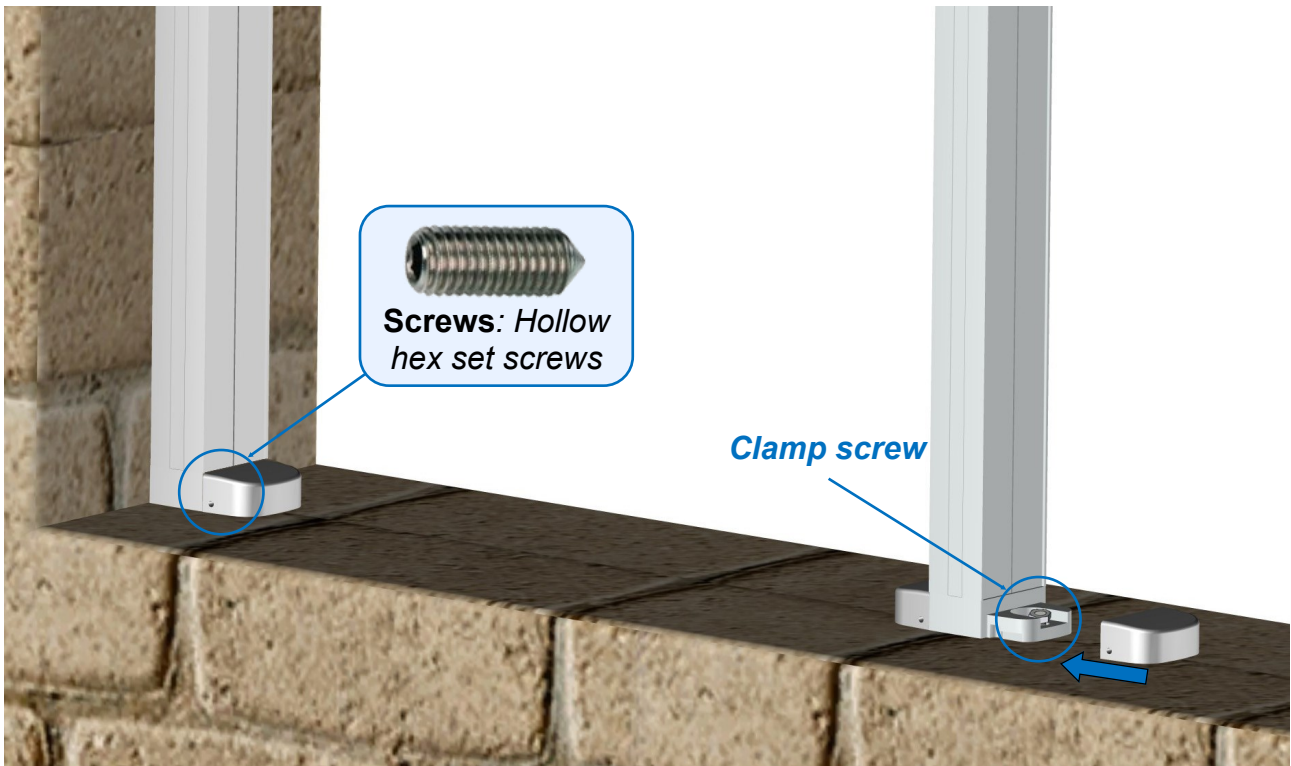

Permanently install the closure:

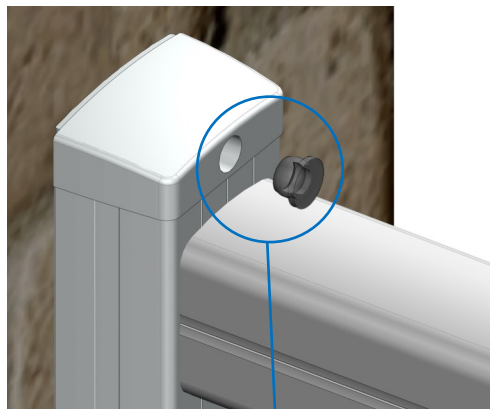
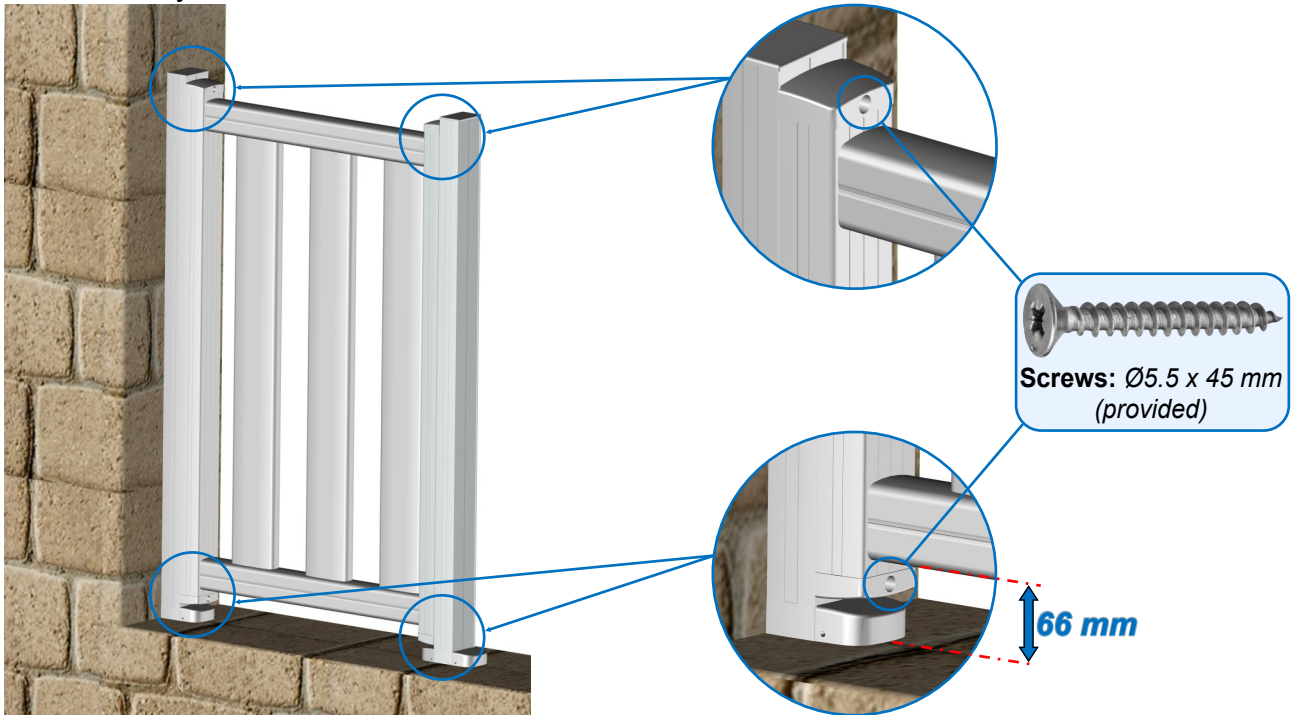

Then insert the stopping plugs

Repeat the process in the section: 'Drill the holes in the 1st post' to install the rest of the closures.

Installing the closures on aluminum posts to be sealed

Before installing the closure, **check:**

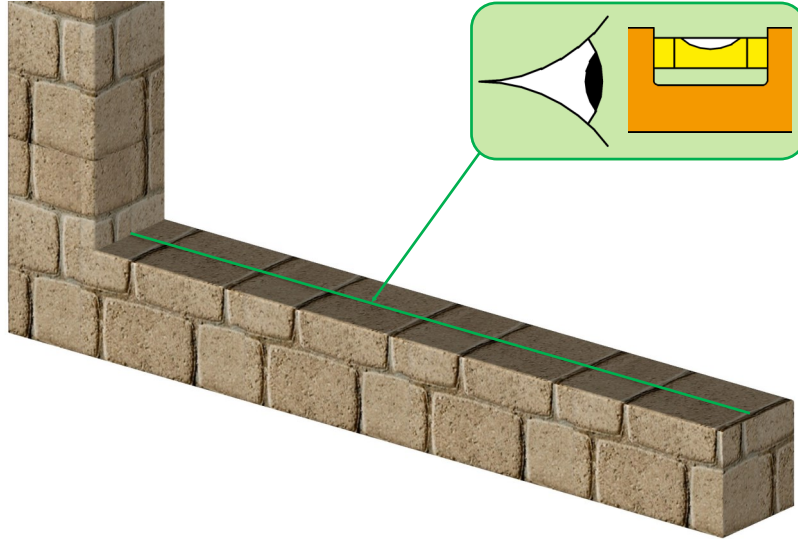

Draw a line, from the bottom of each post:

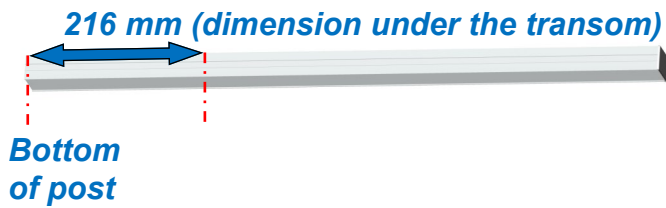

Mark the position of the posts on the installation surface according to the center distance of the closure:

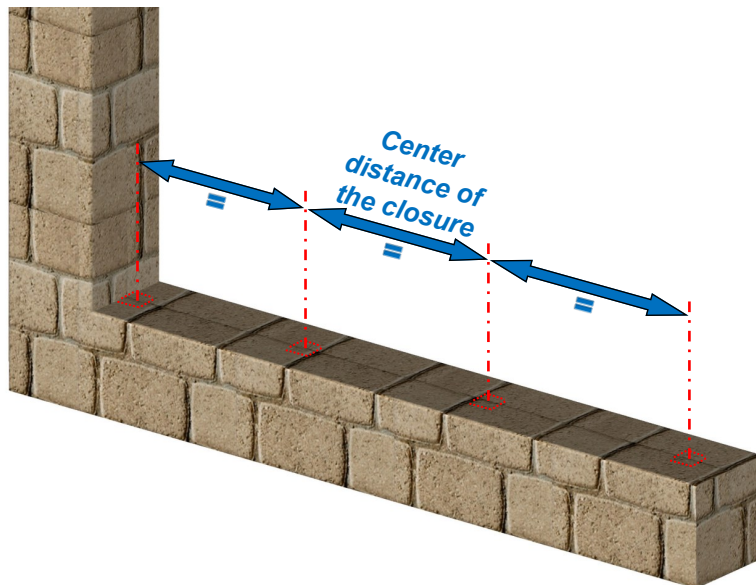

Drill the holes and position the posts, without sealing them:

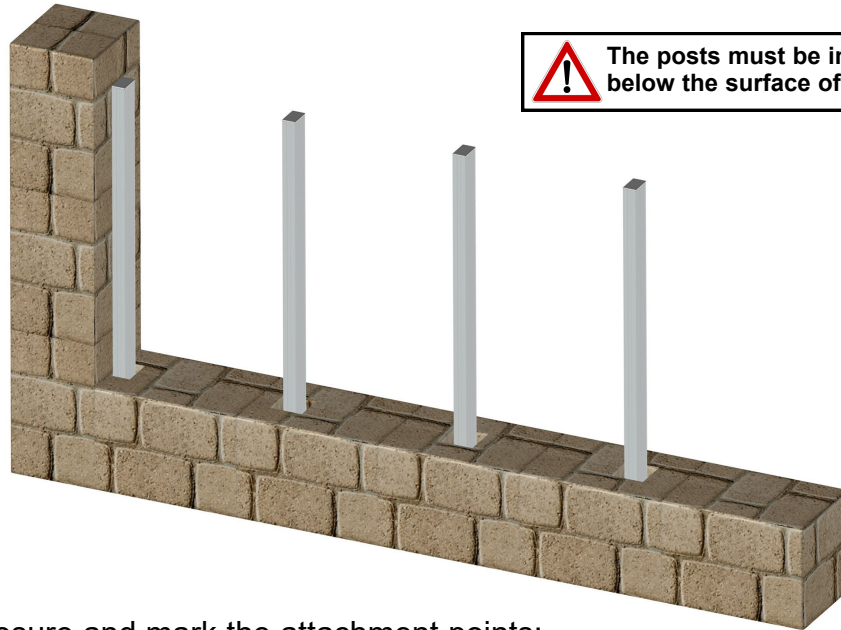

Position the closure and mark the attachment points:

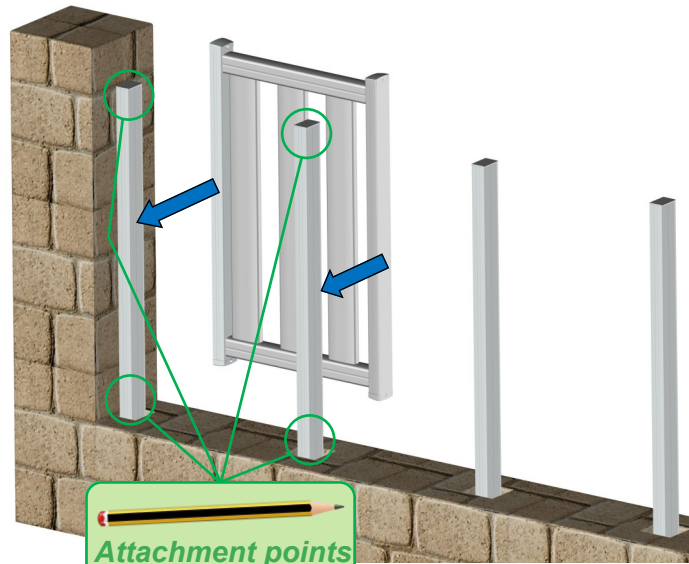

Normal clearance

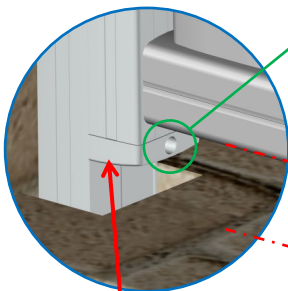

66 mm

**OPTION:
Reduced clearance**

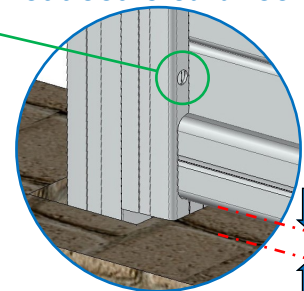

10 mm

**Normal or
reduced clearance**

Please note: If the attachment caps have not been fitted:

- They are in the accessory pack.
- Forcibly insert them using a mallet while protecting the floor so that the caps don't get scratched.

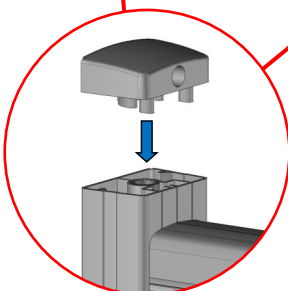

Remove the closure in order to drill the holes, then screw the closure onto the posts:

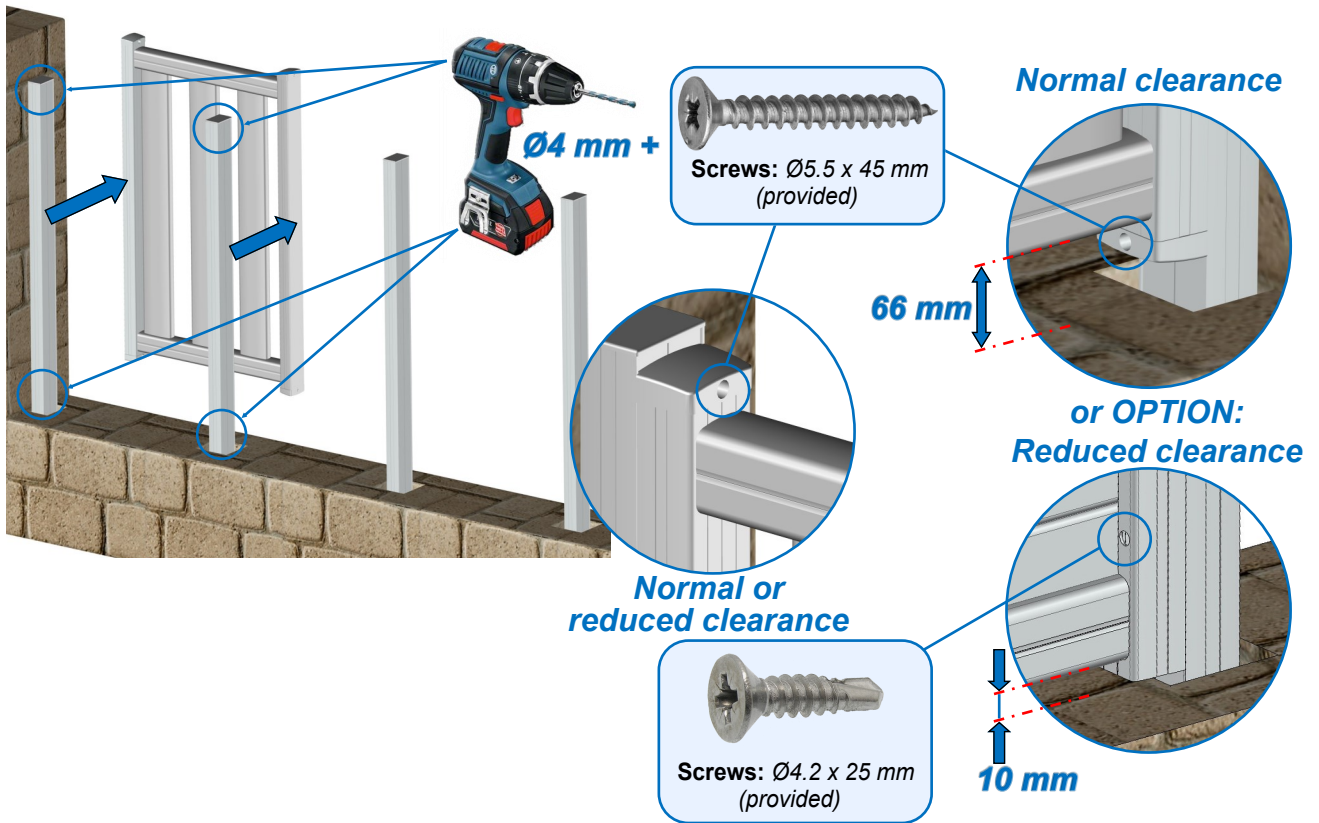

Then insert the stopping plugs

Please note: OPTION: Reduced clearance
Bottom plugs are different = Ø10 mm.

Support the closure and repeat the process from the section:
'Position the closure and mark the attachment points'
to attach the rest of the closures.

Once the closures have all been attached, support the assembly and **check:**

Normal clearance

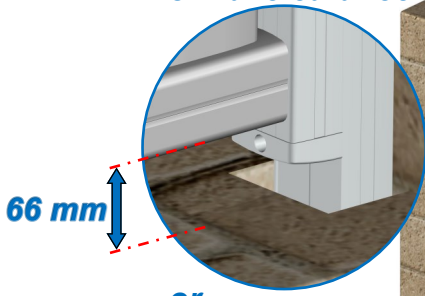

or

**OPTION:
Reduced clearance**

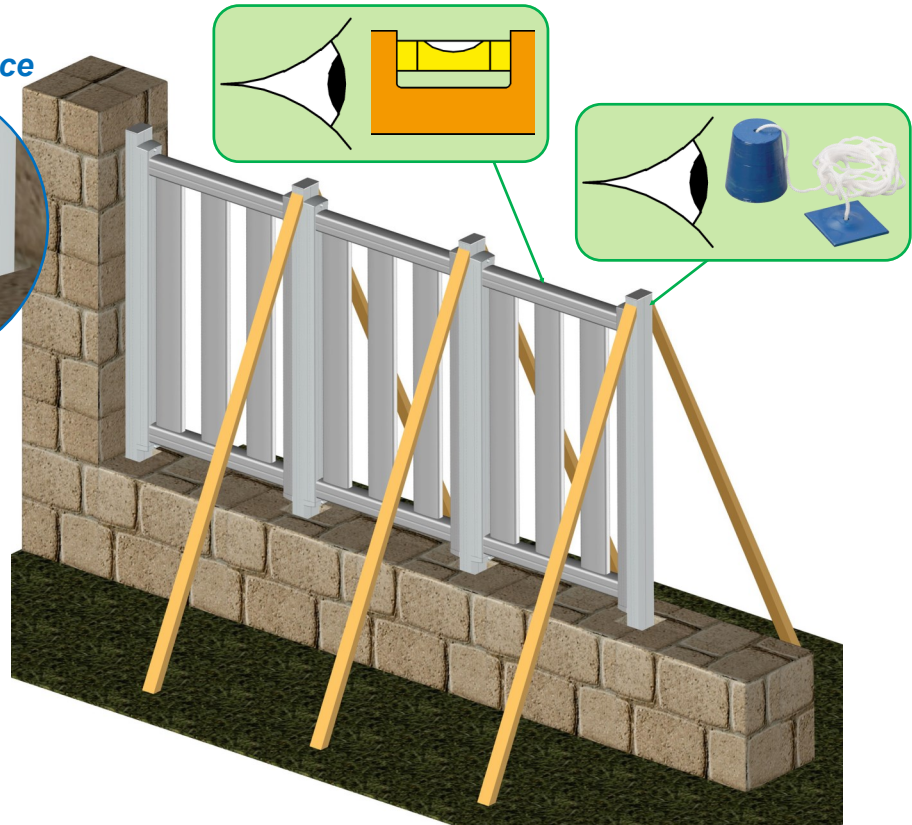
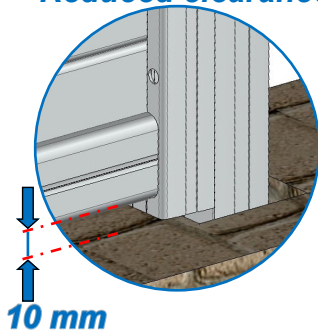

Then seal all of the posts

